

PSA

Panacom

Video Intercom System

User Manual

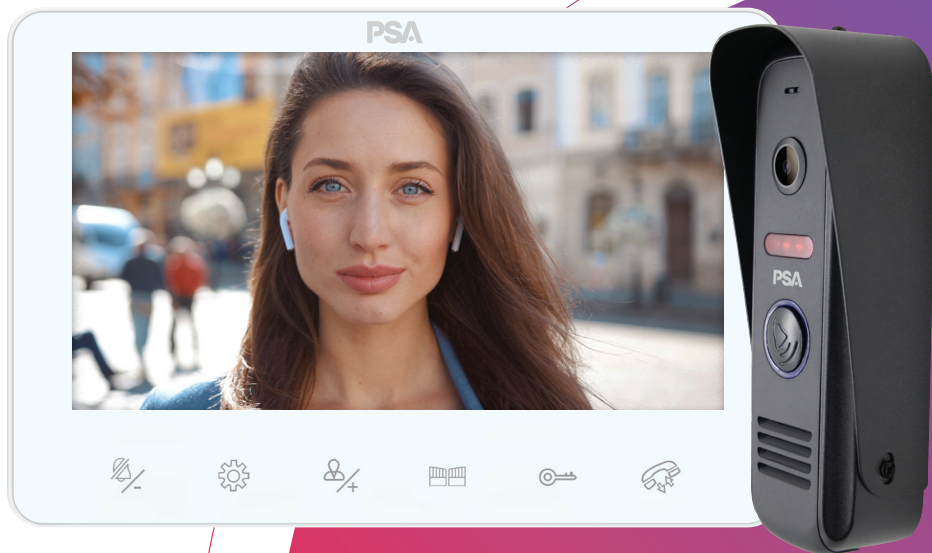

Model:
PAN900SKHD

Introduction

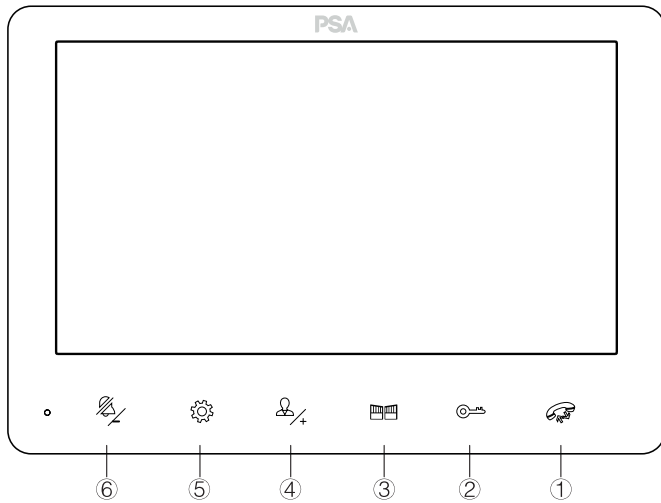

1	Intercom / Answer	Answer call from an external Door Station. Or to hang up a call. Also to call another indoor Monitor. Long press to exit.
2	Unlock Door	Activate Electric Door Strike (of the active Door station)
3	Unlock Gate	Unlock external gate (via rear Unlock port)
4	Monitoring / +	To view/monitor an external Door Station Also to scroll up, or to increase value.
5	Settings	Press to display Settings menu. (Tip: First press Button ④ to wake the Monitor)
6	Do Not Disturb / -	Do Not Disturb mode (On/Off). Also to scroll down, or to decrease value.

System Wiring Diagram

Kit includes Monitor 1 and Door Station 1 only.

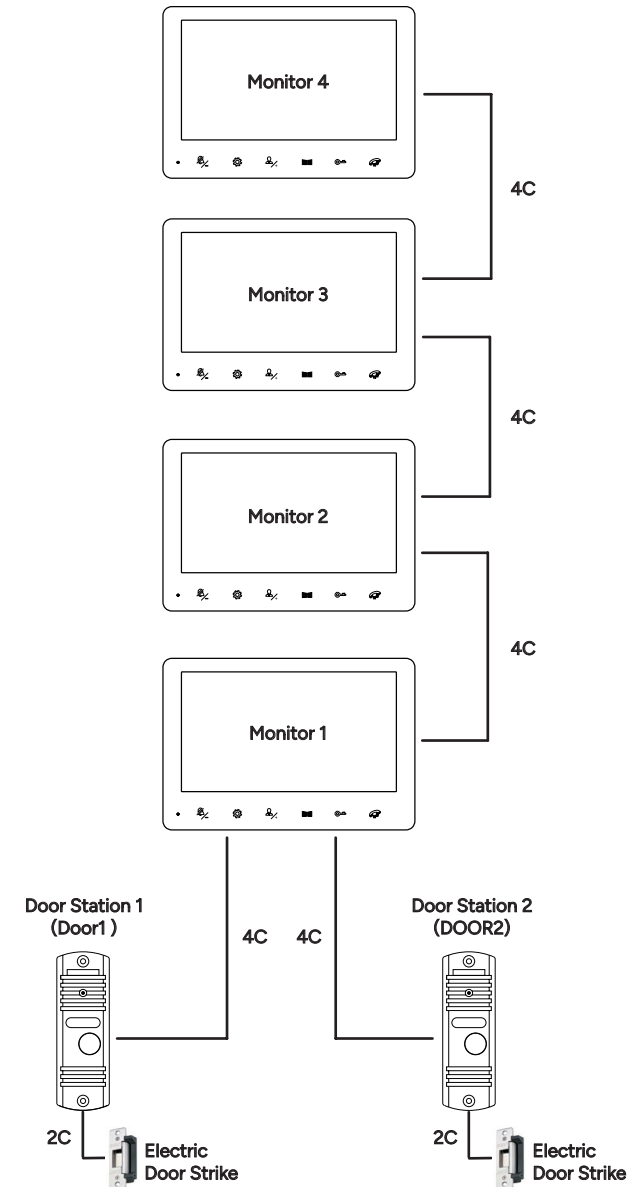

System Wiring Diagram

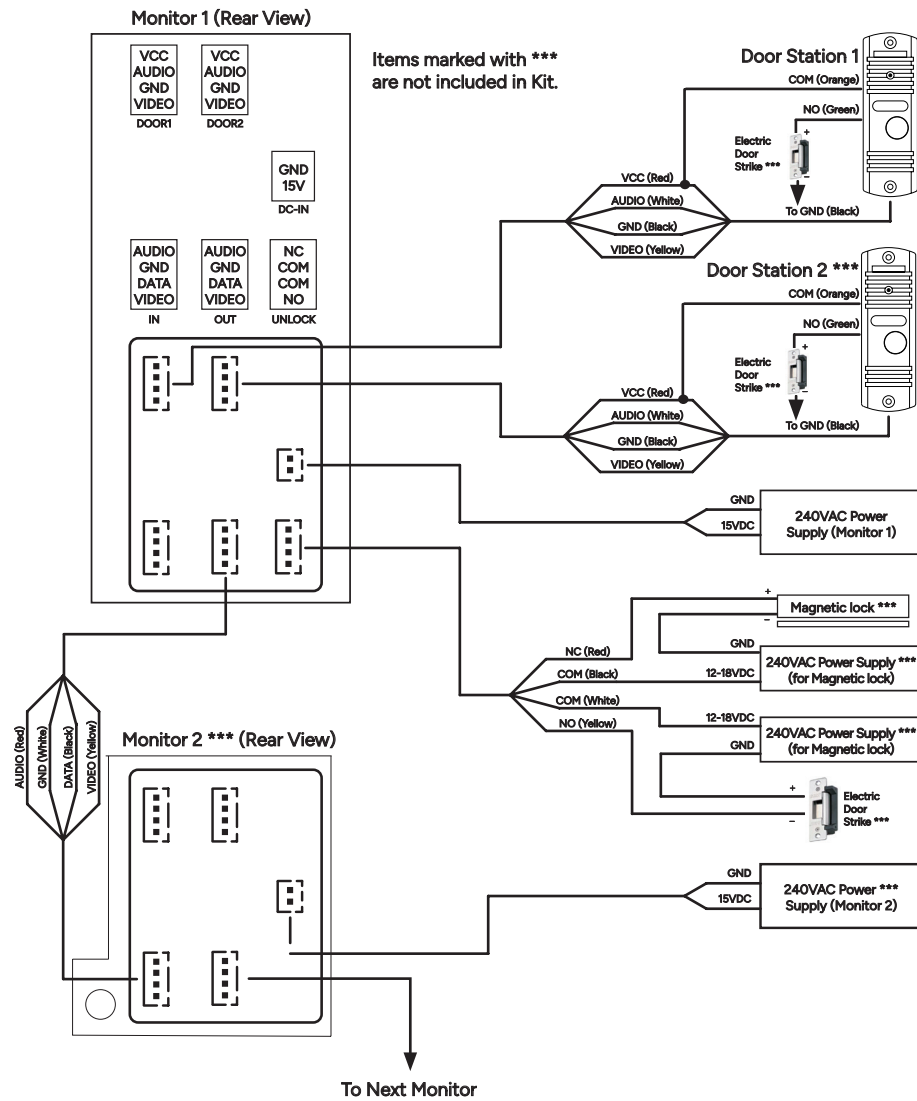

Wiring Notes

- Disconnect power before installation.
- Supports up to 4 internal Monitors and 2 external Door Stations.
- Keep the Intercom wires more than 30cm away from AC mains power to avoid interference.
- The electric door strikes are not included in this Kit. Use 12VDC electric door strikes only. Do not exceed 500mA.

Cable Requirements:

Wiring distance $\leq 50m$. Use 4-core cable with a wire diameter of 0.5 mm^2 or more.
Wiring distance $\leq 80m$. Use 4-core cable with a wire diameter of 0.75 mm^2 or more.

CAT5e or CAT6 Network Cable Wiring Configuration:

1. From Door Station(s) to First Monitor

	RED	BLACK	WHITE	YELLOW
CAT5e or CAT6***	Brown, Blue	Brown/White Blue/White Green/White Orange/White	Green	Orange

2. From First Monitor to Additional Monitor(s):

	RED	BLACK	WHITE	YELLOW
CAT5e or CAT6***	Brown, Blue	Green	Brown/White Blue/White Green/White Orange/White	Orange

*** Cable Distance up to 50m (measured from external door station to last Monitor in daisy-chain).

Installation of Indoor Monitor

- Select an eye-level position to mount the Monitor.
The recommended height is 150cm - 160cm from floor level.
- Keep a distance of 30cm (minimum) from AC Power to avoid electrical interference. Avoid installing near a strong radiation source (eg. TV and computers). Keep the Monitor away from water.
- Do not drop, shake or knock the device to avoid damaging the components.
- Switch off power supply before installation.

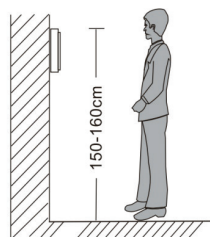

Mounting the Monitor on the wall

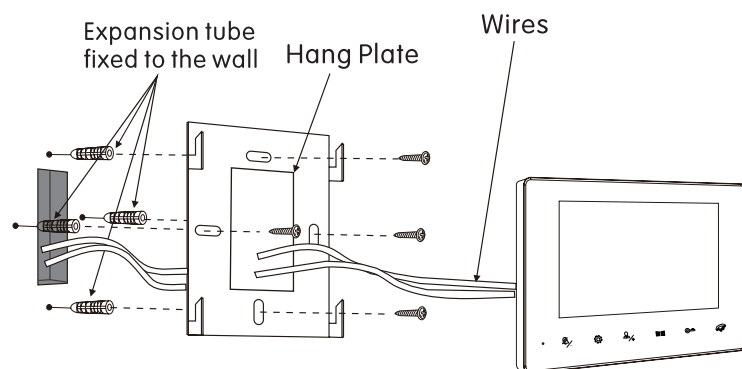



Operating Instructions



Visitor Call

When the Bell button of an external Door Station is pressed, all indoor Monitors will sound their selected ringtone(s). If unanswered, the Monitors will ring for 16 seconds. The call will automatically terminate after a minute.



Answering Call From Door Station

Press the Intercom button  once to answer an incoming call. Press  again to exit. The call will automatically exit after a minute. To decline the call, long press (press and hold) the Intercom button.



Monitoring

When the Monitor is on Standby, press the Monitor button  repeatedly to monitor DOOR1 and DOOR2. While monitoring a Door Station, press  the Intercom button once to talk to that Door Station. Long press  to exit Monitoring mode.













Unlock

Press the Unlock button  to activate the Electric Door Strike (while the Monitor is showing video from that Door Station). Likewise, press the  button to unlock the door that is being monitored.



Intercom Call Between Internal Monitors

If the system has two or more indoor Monitors, press the Intercom button  to call all other Monitors (while on Standby mode). Press the Intercom button  at any other Monitor to answer the call. Long press  to cancel the intercom call.

Settings Menu

Press  to wake up the Monitor. Then press the Settings  button to show the Settings menu. Press  repeatedly to step through the parameters. For a displayed parameter, press  to increase or  to decrease its value. Then press  for the next parameter. The parameters are shown in the following sequence: Brightness , Contrast , Ringtone , Ringtone Volume , Intercom Volume  and Do Not Disturb (DND) . Long press the  button to exit.

Do Not Disturb (DND) Mode

The Do Not Disturb Mode can be turned ON through the Settings menu. When turned on,  the icon will appear on the screen. Alternatively, while on Standby, long press the  button for 3 seconds to enable or disable the Do Not Disturb mode. The Monitor is silenced when the DND Mode is ON.

Specifications

Monitor

Screen Size	7-Inch LCD
Monitor Resolution	1024 x 600 pixels
Video Format	CVBS/AHD
Call Mode	Automatic half duplex
Call Active Time	60s (approx.)
Working Voltage	15V DC
Stand-by Current	100mA (max.)
Working Current	650mA (max.)
Working Temperature	-10~50°C
Installation Method	Surface mount
Dimensions (H x W x D)	125 x 185 x 25mm

Door Station

Camera Sensor	2MP (1080p)
Camera View Angle	110deg Horizontal
Door Station IP Rating	IP65
Material (Door Station)	Metal Housing
Dimensions (H x W x D)	130 x 41.5 x 27mm "

Packing List

Indoor Monitor	1 pcs
Outdoor Door Station	1 pcs
15VDC Power Adapter	1 pcs
Wall Bracket	1 pcs
Screws	4 pcs
Wall Plugs	4 pcs
Lead - 4 Pin Plug	7 pcs
Lead - 2 Pin Plug	1 pcs
User Manual	1 pcs

Warranty & Liability

1. PSA Products Pty Ltd (ABN: 99 076 468 703) of 17 Millicent Street, Burwood 3125 Victoria, Australia warrants this product for a period of 12 months from the date of purchase, as reflected on the Authorised Resellers or Distributors invoice/ receipt provided to you. PSA Products Pty Ltd will repair or replace the product (at the option of PSA Products) due to any manufacturing defect, at the cost of PSA Products Pty Ltd (excluding any labour costs relating to removal or re-installation of product, and transport costs).
2. This warranty shall not apply to the product if it has been damaged, modified, abused or altered after the date of purchase, or if it fails to operate due to improper maintenance.
3. To the extent permitted by law, the liability of PSA Products Pty Ltd arising from the sale or under the terms of this limited warranty shall not in any case exceed the cost of replacement and subject to this clause. In no case shall PSA Products Pty Ltd be liable for consequential loss or damages resulting from the failure of the product or breach of this, or: Any other warranty, express or implied, loss or damage caused by failure to abide by the instructions supplied in the leaflets.
4. To the extent permitted by law, PSA Products Pty Ltd., makes no warranty, expressed or implied, written or oral, including that of merchantability or fitness for any particular purpose, with respect to the consumer replaceable battery if any. A product with nonserviceable builtin battery is covered under warranty of the product as per point 1.
5. This warranty is provided in addition to other rights and remedies you have under law: Our goods come with guarantees that cannot be excluded under the Australian Consumer Law. You are entitled to a replacement or refund for a major failure and compensation for any other reasonably foreseeable loss or damage. You are also entitled to have the goods repaired or replaced if the goods fail to be of acceptable quality and the failure does not amount to a major failure. What constitutes a major failure is set out in the Australian Consumer Law.
6. To make a claim under warranty, take the product (with a proof of purchase) to the store where you purchased the product or contact PSA Products Pty Ltd. Phone (03) 9888 9889. or Email: enquiry@psaproducts.com.au with details, proof of purchase or expense claim in writing.

PSA

PSA Products Pty Ltd
17 Millicent St, Burwood,
VIC 3125 Australia

T. 1300 772 776

enquiry@psaproducts.com.au
psaproducts.com.au