



**HOME GUARD™**

MODEL HG1000

## **INSTALLATION AND USER MANUAL**

### **SMOKE ALARM IONISATION DESIGN**

**240VAC MAINS POWERED SINGLE STATION AND/OR INTERCONNECTABLE (24 UNITS) IONISATION SMOKE ALARM. 9V REPLACEABLE BATTERY BACKUP. TEST AND HUSH CONTROL AND LOW BATTERY INDICATION.**

**IMPORTANT: READ ALL INSTRUCTIONS BEFORE INSTALLATION.**

**NO USER REPLACEABLE PARTS INSIDE THIS SMOKE ALARM.**

**WARNING: Disconnecting smoke alarm from mounting base and/or removing the 9V battery will render this smoke alarm inactive.**

### **SPECIFICATION**

**ELECTRICAL RATING: 240VAC 50Hz, 80mA per alarm and interconnectable to 24 alarms.**

**WARNING: THIS SMOKE ALARM MUST ONLY BE WIRED TO A 240Vac 50Hz SINE WAVE CURRENT SUPPLY.**

**THE SMOKE ALARM USES AN EXTREMELY SMALL AMOUNT OF A RADIOACTIVE IN THE IONISATION CHAMBER.**

## CONTENTS

|  |    |
|--|----|
| RECOMMENDED LOCATIONS OF ALARMS .....            | 1  |
| MOBILE HOME INSTALLATION .....                   | 3  |
| AVOID THESE LOCATIONS .....                      | 3  |
| FALSE ALARMS .....                               | 4  |
| HOW TO REMOVE SMOKE ALARM FROM BASE PLATE .....  | 5  |
| INSTALLATION .....                               | 5  |
| OPERATION, TESTING AND MAINTENANCE .....         | 11 |
| BATTERY INSTALLATION, REPLACEMENT AND TEST ..... | 14 |
| REPAIRS AND SERVICES .....                       | 15 |
| GOOD SAFETY HABITS .....                         | 15 |
| THE LIMITATIONS OF SMOKE LARMS .....             | 15 |
| OPERATING PRINCIPLES OF SMOKE ALARMS .....       | 17 |
| DEVELOP AND PRACTICE A PLAN OF ESCAPE .....      | 18 |
| WHAT TO DO WHEN THE ALARM SOUNDS .....           | 19 |
| INSTALLER PLEASE NOTE .....                      | 20 |
| WARNING: INSULATION TEST .....                   | 20 |
| WARRANTY AND LIABILITY .....                     | 21 |

## 1. RECOMMENDED LOCATIONS OF ALARMS

- 1.1 Locate an alarm for each separate sleeping area in the immediate vicinity of the bedrooms. Try to monitor the exit path as the bedrooms are usually farthest from an exit. If more than one sleeping area exit, locate additional alarms in each sleeping area in the immediate vicinity bedrooms.
  - 1.2 Locate additional alarms to MONITOR any stairway as stairways act like chimneys for smoke and heat.
  - 1.3 Locate at least one alarm on every floor level.
  - 1.4 Locate an alarm in every room where a smoker sleeps.
  - 1.5 Locate an alarm in every room where electrical appliances are operated (i.e. portable heaters or humidifiers).
  - 1.6 Locate an alarm in every room where someone sleeps with the door closed. The closed door may prevent an alarm not located in that room from waking the sleeper.
  - 1.7 Smoke, heat and other combustion products rise to the ceiling and spread horizontally. Mounting the alarm on the ceiling in the center of the room places it closest to all points in the room. Ceiling mounting is preferred in ordinary residential construction.
  - 1.8 For mobile home installation select location carefully to avoid thermal barrier that may form at the ceiling. For more details see Mobile Home Installation (Section 2).
  - 1.9 When mounting alarms on the ceiling locate it at least 300mm away from the side wall and 300mm away from any corner. (see diagram)
  - 1.10 When mounting alarms on a wall, use the inside wall. The recommended position is between 300mm and 500mm off the ceiling. (see diagram)
- NOTE: The performance of smoke alarms mounted on walls is unpredictable and this mounting position is not recommended when ceiling mounting can be implemented.**

## 1. RECOMMENDED LOCATIONS OF ALARMS

- 1.11 When mounting the alarm at the apex of a sloping ceiling it should be located at least 500mm away from the apex but should not exceed 1500mm (see diagram).
- 1.12 Locate smoke alarm at both ends of a bedroom hallway or large room if the hallway or room is more than 9m long.
- 1.13 Do not locate smoke alarms in kitchen areas due to potential nuisance alarms from cooking fumes.

### INSTALLATION OF SMOKE ALARM

**APEX OF SLOPING CEILING**

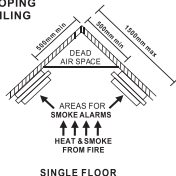

**SINGLE FLOOR**

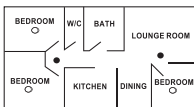

- Smoke alarms for minimum protection.
- Smoke alarms for additional protection.

**CEILING/ WALL JUNCTION**

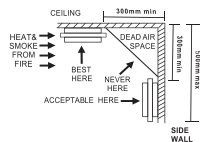

**TYPICAL MULTIPLE FLOOR INSTALLATION**

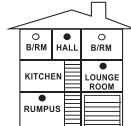

**IMPORTANT: INCORRECT ORIENTATION OF SMOKE ALARM MAY DECREASE OPERATIONAL EFFECTIVENESS**

## 2. MOBILE HOME INSTALLATION

- 2.1 Modern mobile homes have been designed and insulated to be energy efficient. Install smoke alarms as recommended (refer to RECOMMENDED LOCATIONS).
- 2.2 In older mobile homes that are not well insulated compared to present standards, extreme heat or cold can be transferred from the outside through poorly insulated walls and roof. This may create a thermal barrier which can prevent smoke from reaching a smoke alarm mounted on the ceiling. In such units, install smoke alarm on inside partition between 300mm and 500mm from the ceiling.
- 2.3 If you are not sure about the insulation in your mobile home, or if you notice the walls and ceilings are either hot or cold, install alarm on an inside wall. For minimum protection, install one alarm close to the bedrooms. For additional protection, see **SINGLE FLOOR PLAN**.
- NOTE: TEST YOUR SMOKE ALARM OPERATION AFTER MOBILE HOME VEHICLE HAS BEEN IN STORAGE, BEFORE EACH TRIP AND AT LEAST ONCE WEEK DURING USE.**

## 3. AVOID THESE LOCATIONS

- 3.1 Do not locate your alarm in the garage - products of combustion are present when you start your automobile. Use Heat Alarm in this location.
- 3.2 Do not locate your alarm in front of forced air supply ducts used for heating and air conditioning and other high air flow areas.
- 3.3 Do not locate your alarm less than 500mm from the peak of an "A" frame type ceiling.
- 3.4 Do not locate your alarm in areas where temperatures may fall below 5°C or rise above 45°C, or in humidity higher than 85% as these conditions may reduce battery life.

### **3. AVOID THESE LOCATIONS**

- 3.5 Avoid dusty areas, dust particles may cause smoke alarm to false alarm or fail to alarm. Use Heat Alarm in this location to avoid false alarms.
- 3.6 Avoid very humid areas or near a bathroom, moisture can cause false alarm.
- 3.7 Avoid insect-infested areas.
- 3.8 Do not locate alarm within 0.9m of the following: the door to a kitchen, the door to a bathroom containing a tub or shower, ceiling or whole house ventilating fans, or other high flow areas.
- 3.9 Avoid locating near fluorescent lights or other electrical equipment. Electronic magnetic interferences or “noise” may cause nuisance alarms or chirping.
- 3.10 Smoke alarms are not to be used with detector guards unless the combination (alarm and guard) has been evaluated and found suitable for that purpose.

### **4. FALSE ALARMS**

- 4.1 This smoke alarm is designed to minimize false alarms. Smoking will not normally set off the alarm unless smoke is blown directly into the alarm.
- 4.2 Combustion particles from cooking may set off the alarm if the alarm is located close to the kitchen cooking surface.
- 4.3 Large quantities of combustion particles are generated from spills and over-boil.
- 4.4 An alarm with a Hush® Control device is preferable near a kitchen environment for this reason.
- 4.5 Photo-electric type smoke alarms are less prone to false alarm near kitchen areas than ionisation type smoke alarms.
- 4.6 If the alarm does sound, check for fire first. If a fire is discovered, escape quickly and call the Fire Brigade. If no fire is present, check to see if one of the reasons listed above may have caused the alarm.

## 5. HOW TO REMOVE SMOKE ALARM FROM BASE PLATE

- 5.1 If the smoke alarm tamper resist feature has been installed, refer to the Alarm Tamper Resist Feature section for removal instructions. (See page 10)
- 5.2 To remove the alarm from the mounting plate, rotate the alarm in the direction of the "OFF" arrow on the cover.
- 5.3 To disconnect the AC Quick-Connect wire harness, squeeze the locking arms on the sides of the Quick Connector while pulling the connector away from the bottom of the alarm (see Image 1B).

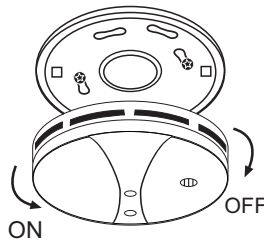

ROTATE TO MOUNT OR  
TO REMOVE

## 6. INSTALLATION

**WARNING: THIS SMOKE ALARM MUST BE INSTALLED BY QUALIFIED (LICENSED) ELECTRICIANS ONLY.**

- 6.1 **Wiring Instructions:**
- 6.1.1 In the interests of safety, this smoke alarm and all wiring must be installed by a licensed electrician in accordance with the relevant requirements of the SAA Wiring Rules - AS3000.
- 6.1.2 DO NOT connect this smoke alarm on the base plate without the presence of 240V mains power.

## 6. INSTALLATION

- 6.1.3 This Smoke Alarm can only interconnect with Homeguard Model HG1000. Interconnection with other brands may cause damage or result in a shock or fire risk and void warranty.
- 6.1.4 Due to “noise” from electromagnetic interference, up to 24 units of smoke alarms may be interconnected.
- 6.1.5 There are three terminals in the supply terminal block, marked A, S, N. It is important that the alarm be wired correctly to ensure correct operation. Incorrect wiring to the Smoke Alarm will damage the unit and void the warranty.
- 6.1.6 A total maximum of 250 meters (820 feet) of wire can be used in interconnecting smoke alarms.
- 6.1.7 All final sub-circuit conductors including the signal conductor must be a minimum size of 1mm<sup>2</sup> with 250V grade insulation.
- 6.1.8 Interconnected Smoke Alarms must be connected to the same final subcircuit.
- 6.1.9 Do not use any wire that could later be confused with the normal house wires for the interconnect wire. For example, green/yellow earth wire.
- 6.1.10 Do not connect AC power wires to S interconnect terminal. These will damage smoke alarms.
- 6.1.11 Do not connect the S interconnect wire to any device, except the S interconnect terminal of smoke alarm. Otherwise, smoke alarm will be damage.
- 6.1.12 Smoke alarms should be interconnected only within the confines of a single family living unit. If smoke alarms are interconnected between different units, there may be excessive nuisance alarms. Residents may not be aware that smoke alarms are being tested or that it is a nuisance alarm caused by cooking, etc.



## 6. INSTALLATION

6.1.13 Terminals are marked as follows:

MARKINGS

(Red) A ACTIVE

(White) S SWITCH WIRE (FOR INTERCONNECTION ONLY)

(Black) N NEUTRAL

**WARNING:** Connecting the Switch wire terminal to any other supply conductor may result in damage to the alarm, failure to operate or shock hazard and void the warranty of the alarm.

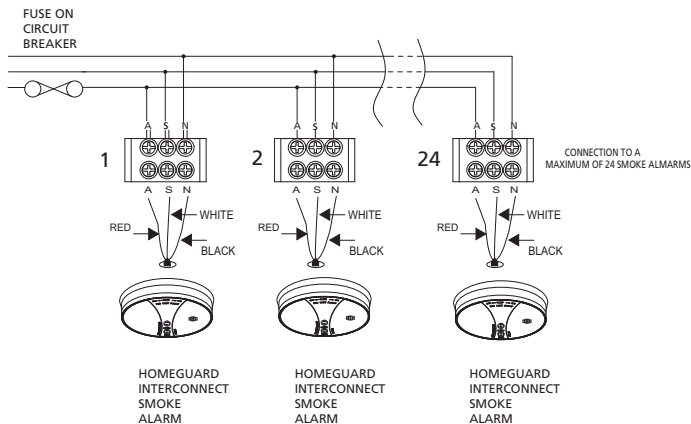

## 6. INSTALLATION

- 6.1.14 When interconnected all Smoke Alarms will sound upon activation.
- 6.1.15 **WARNING:** This alarm cannot be operated from power derived from a square wave, modified square wave or modified sine wave inverter. These type of inverters are sometimes used to supply power to the structure in off grid installations, such as solar or wind derived power sources. These power sources produce high peak voltages that will damage the alarm.
- 6.1.16 PSA recommend the smoke alarms to be installed on its own subcircuit to avoid false alarms and nuisance chirping that may be caused by electromagnetic interferences from other electrical equipment.

### 6.2 Mounting Instructions:

- 6.2.1 Pull the AC Quick-Connect wire harness through the centre hole in the mounting plate and secure the plate, making sure that the mounting screws are positioned in the small ends of the keyholes before tightening (Image 1A).
- 6.2.2 Press the battery reminder tab down into the battery compartment while inserting the battery (Image 1D).
- 6.2.3 **CAUTION:** If the battery reminder tab is not held down in the battery compartment by the battery, the battery door will not close and the unit will not attach to the mounting plate.
- 6.2.4 Plug the AC Quick-Connect wire harness into the back of the alarm (Image 1B), making sure that the locks on the connector snap into place. Push the excess wire back into the electrical box through the hole in the center of the mounting plate.

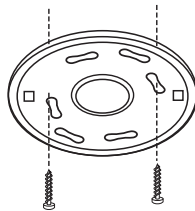

**IMAGE 1A**

## 6. INSTALLATION

- 6.2.5 Alignment marks are provided on the edge of the mounting plate and the alarm. After installing the mounting plate, place the alarm onto the mounting plate, making sure the alignment marks are lined up. Twist the alarm in the direction indicated by the “ON” arrow on the alarm cover (Image 1C) until it locks in place.

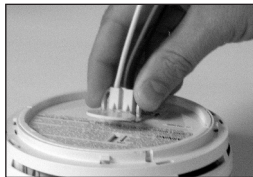

SQUEEZE THE LOCKING PIN OF THE AC QUICK-CONNECT WIRE HARNESS

**IMAGE 1B**

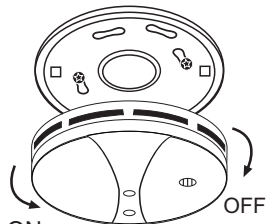

ROTATE TO MOUNT OR TO REMOVE

**IMAGE 1C**

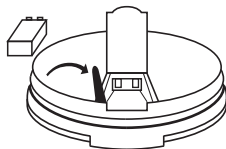

BATTERY REMINDER TAB

**IMAGE 1D**

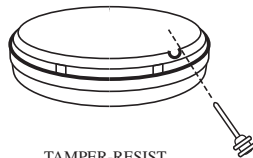

TAMPER-RESIST LOCKING PIN

**IMAGE 1E**

## 6. INSTALLATION

### 6.3 **TEST & Battery Backup:**

- 6.3.1 Homeguard model HG1000 will not function without a properly installed battery. They are equipped with a battery lockout feature which prevents the battery door from closing if a battery is not installed correctly (See Image 1D).
- 6.3.2 To ensure proper operation of models with battery backup, press the Test button for at least 5 seconds, or until the alarm sounds (without the AC power connected). All interconnected, battery backed-up alarms, should respond.
- 6.3.3 CAUTION: Due to the loudness (85 decibels) of the alarm, always stand an arms-length away from the unit when testing.
- 6.3.4 Turn on the AC power. The green LED power indicator should be lit when the alarm is operating from AC power.
- 6.3.5 Confirm unit operation by pressing the Test button again.
- 6.3.6 The smoke alarm is operating once AC power is applied, a fresh battery is installed and testing is complete. When the smoke alarm ionization sensor chamber senses products of combustion, the horn will sound a loud (85db) alarm until the sensing chamber is cleared of smoke particles.

### 6.4 **Alarm Tamper Resist Feature:**

- 6.4.1 The smoke alarm is operating once AC power is applied, a fresh battery is installed and testing is complete. When the smoke alarm ionisation sensor chamber senses products of combustion, the horn will sound a loud (85db) alarm until the sensing chamber is cleared of smoke particles.

**NOTE: The tamper-resistant pin will have to be removed in order to change the battery . Use long nose pliers to pull the pin out of the hole. It is now possible to remove the alarm from the mounting plate (See Image 1E) .**

## 7. OPERATION, TESTING AND MAINTENANCE

### 7.1 **Operation:**

7.1.1 The smoke alarm is operational once all wires are properly connected, a fresh battery is installed (HG1000), The smoke alarm is correctly installed on the mounting base and the alarm has been tested.

7.1.2 There are two LED indicators. Each of them has a unique function:

#### 7.1.3 **Red LED**

7.1.3.A **Stand-by condition:** will flash once approximately every 40 seconds to indicate unit is functioning properly.

7.1.3.B **Alarm condition:** the Red LED will flash once every second. For interconnected units, the originating smoke alarm Red LED will flash once every second. All other units will sound but the Red LED will not be on or flashing.

#### 7.1.4 **Green LED**

7.1.4.A **AC Mains-ON Indicator:** indicates that the unit is operating with AC power. If this LED goes out, it indicates that the AC power is off.

### 7.2 **False Alarm Hush Control Feature:**

**Note: Dense smoke will override Hush control feature and sound a continuous alarm.**

7.2.1 This smoke alarm has the capability of being temporarily desensitized for approximately 5-15 minutes.

7.2.2 The smoke alarm is desensitized by pressing the “ Test / Hush ” button on the smoke alarm cover.

7.2.3 After pressing the “ Test / Hush ” button, the alarm will silence immediately.

7.2.4 The smoke alarm will automatically reactivate after approximately 5-15 minutes and sound the alarm if particles of combustion are still present.

7.2.5 The “HUSH” feature may be used repeatedly until the air has cleaned.

**WARNING: Before using the alarm HUSH feature, identify the source of smoke and be certain that a safe condition exists.**

## 7. OPERATION, TESTING AND MAINTENANCE

### 7.3 Operating and Alarm Characteristics.

| Function    | LED Status  | Recommendation   |
|-------------|---|--|
| Normal      | Green ON  | Green LED indicate the AC mains power is present.  |
| Normal      | Red FLASHING every 40 seconds.                                    | Red LED flashes every 40 seconds is normal. The smoke alarm performs a self test every 40 seconds. The battery and electronics is tested for the life of the unit. |
| Alarm mode  | Red light flashing once every second. Smoke alarm activated.      | Indicate smoke alarm has activated and is in alarm mode.   |
| Alarm mode  | Red Light is OFF. Smoke alarm activated.                          | Smoke alarm in full alarm. Other interconnected units may have activated the alarm. Check other smoke alarms or devices.   |
| Hush mode   | Green light ON. Red light flashing every 10 seconds and no chirp. | The "HUSH" feature has the capability of temporarily desensitizing the alarm circuit for approximately 8 minutes.  |
| Low Battery | Green ON, Flashing red light every 40 seconds.                    | Smoke alarm chirp every 40 Seconds. May indicate low battery status. Replace the battery.  |

## 8. BATTERY INSTALLATION, REPLACEMENT AND TEST

### 8.1 Battery Installation

- 8.1.1 The smoke alarm uses one 9V battery to automatically provide back-up power to the alarm if AC power fails. The battery will operate the alarm for approximately one to three months with AC power off.
- 8.1.2 The smoke alarm has a low battery indicator that will cause the unit to chirp and flash the Red LED at approximately 40 second intervals for a minimum of 7 days. Missing battery with main power connected will cause the unit to chirp and flash the Red LED at approximately 40 second intervals.
- 8.1.3 Replace battery when chirping occurs. To ensure proper operation, the battery should be replaced once a year.
- 8.1.4 To replace battery, remove alarm from mounting base(see section 6.2) and remove the battery from compartment. Replace the old battery with a new one.
- 8.1.5 **USE ONLY THE FOLLOWING 9 VOLT BATTERIES FOR**

#### **SMOKE ALARM REPLACEMENT.**

Carbon Zinc Type:GOLD PEAK 1604P

Alkaline Type: ENERGIZER 522; DURACELL MN1604, MX1604;  
GOLD PEAK 1604A;

Lithium Type: ULTRALIFE U9VL-J

These batteries can be purchased at your local retail outlet or supermarket.

**Caution: Use only specified batteries. Use of different battery may have a detrimental effect on operation or may cause the battery to explode resulting in injury or fire.**

## 8. BATTERY INSTALLATION, REPLACEMENT AND TEST

- 8.1.6 **USE ONLY BATTERIES SPECIFIED ON THE LABEL .**
- 8.1.7 Fold Red Battery Lever down into compartment with fresh replacement battery. If the Red Battery Lever is not held down in the battery compartment by the battery, the smoke alarm will not close and will not be operational. Battery can only be inserted in one direction, ensure polarity is correct.

**WARNING: Use of inferior batteries or incorrect types may cause a malfunction of the alarm. When replacing the battery and on reconnection of the detector to the base plate, make sure that the detector is fully connected and flush with the base plate. Verify that the Green LED is ON after reinstalling the alarm on the base plate.**

### 8.2 Battery Test:

- 8.2.1 Switch off mains power. The Green LED on the smoke alarm will be OFF.
- 8.2.2 Test alarm by pressing on the Test Button for a few seconds. This should sound the alarm.
- 8.2.3 If the battery module has a fault, the alarm will chirp every 40 seconds.
- 8.2.4 Watch the Red LED for about 40 seconds. It should flash at least once.
- 8.2.5 Switch on mains power only when smoke alarm passes the above tests. The Green LED on the smoke alarm will come ON.

**NOTE: WEEKLY TESTING IS RECOMMENDED!**



## 9. REPAIRS AND SERVICES

- 9.1 If the smoke alarm is defective in any way, do not tamper with the unit. Return the unit to your supplier (See warranty for instructions on in-warranty returns). There will be a service charge for repairing units out of warranty.

### WARNING: DO NOT TAMPER WITH RADIOACTIVE SOURCE

## 10. GOOD SAFETY HABITS

**The use of this product should not be seen as a substitute for basic safety precaution in the prevention of FIRE.**

There are situations where a smoke alarm may not be effective to protect against fire:

- 10.1 smoking in bed;
- 10.2 leaving children home alone;
- 10.3 cleaning with flammable liquids, such as petrol.

## 11. THE LIMITATIONS OF SMOKE ALARMS

- 11.1 Smoke alarms are devices that can provide early warning of possible developing fires at a reasonable cost.
  - 11.2 Alarms have sensing limitations. Ionisation sensing alarm may detect invisible fire particles (associated with fast flaming fires) sooner than Photo-electric alarms. Photo-electric sensing alarm may detect visible fire particles (associated with slow flaming fires) sooner than Ionisation alarms. Home fires develop in different ways and are often unpredictable. Neither type of alarm (photo-electric/ionisation) is always best and a given alarm may not always provide warning of a fire. We strongly recommend that both ionisation and photoelectric smoke alarms be installed to help insure maximum detection of the various types of fires that can occur within the home.
  - 11.3 Smoke alarms have certain limitations. For battery powered smoke alarms, the battery must be in good condition and installed properly.
  - 11.4 AC powered alarms will not operate if AC power has been cut off, such as by an electrical fault, open fuse or circuit-breaker, or fire. However, the battery back-up will activate the alarm if in good working order.
- 15

## **11. THE LIMITATIONS OF SMOKE ALARMS**

- 11.5 Smoke alarms must be tested regularly to ensure that the batteries and alarm circuit are in good operating condition.
- 11.6 Smoke alarms cannot provide an alarm if smoke does not reach the alarm. Therefore, smoke alarm may not sense fires starting in chimneys, walls, on roofs, on the other side of a closed door, or on a different floor.
- 11.7 If the alarm is located outside the bedrooms, or on a different floor, it may not wake up a sound sleeper. A smoke alarm in the bedroom, therefore, is recommended.
- 11.8 Smoke alarms have been significant in saving lives in many parts of the world. Hence, the use of this product does not substitute for basic prevention and total protection.
- 11.9 Although smoke alarms can help save lives by providing early warnings of a fire, they are not a substitute for an insurance policy.
- 11.10 This smoke alarm alone will not alert the hearing impaired. Use special purpose smoke alarm with lights or vibrating devices, for those hard of hearing.
- 11.11 Heat alarms are available to offer greater security when used in conjunction with smoke alarms.
- 11.12 Life safety from fire in residential occupancies is based primarily on early notification to occupants of the need to escape, followed by the appropriate egress actions by those occupants. Fire warning systems for dwelling units are capable of protecting about half of the occupants in potentially fatal fires. Victims are often intimate with the fire, too old or young, or physically or mentally impaired such that they cannot escape even when warned early enough that escape should be possible. For these people, other strategies such as protection-in-place or assisted escape or rescue are necessary.

## 12. OPERATING PRINCIPLES OF SMOKE ALARMS IONISATION CHAMBER:

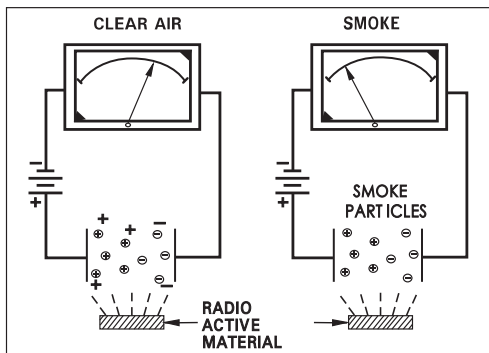

A man-made radio-active element, Americium 241 is used in this design. This element ionises the air round it and as a result, excellent conductivity is possible refer to illustration showing 'Clear Air'. Current supplied by either the mains power (where applicable), or the battery would pass through the gap with ease without causing any alarm. However, in the event of particles arising from combustion or dust particles (refer illustration showing 'Smoke') entering the Sensing Chamber, it encapsulates the ionised air. This interaction causes an increased resistance to conductivity. When this occurs, the alarm is activated.

**Ionisation type smoke alarm is best for detecting flaming fires.**

## 12. OPERATING PRINCIPLES OF SMOKE ALARMS

### PHOTOELECTRIC CHAMBER:

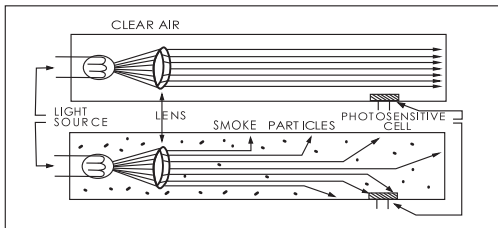

A light transmission source and a photosensitive receiver is used in this design. Light that is transmitted fall upon the receiver. When smoke or dust enters the light path, some of the light is scattered or absorbed. The result of a reduction of light falling upon the photosensitive receiver will cause an alarm.

**Photoelectric smoke alarm is best for detecting smouldering fires.**

## 13. DEVELOP AND PRACTICE A PLAN OF ESCAPE

### BASIC OF ESCAPE PLAN:

- 13.1 Make a floor plan indicating all doors and windows and at least two escape routes from each room. Second storey windows may need a rope or chain ladder.
- 13.2 Have a family meeting and discuss your escape plan, showing everyone what to do in case of fire.
- 13.3 Determine a place outside your home where all of you can meet, if a fire occurs.
- 13.4 Familiarize everyone with the sound of the smoke alarm and practice leaving your home when they hear it.

### 13. DEVELOP AND PRACTICE A PLAN OF ESCAPE

- 13.5 Practice a fire drill at least every six months including drills at nights. Practice allows you to test your plan before an emergency. You may not be able to reach your children. *It is important that they know what to do!*
- 13.6 Install and maintain fire extinguishers on every level of the home and in the kitchen, basement and garage. Know how to use a fire extinguisher prior to an emergency.
- 13.7 Current studies have shown smoke alarms may not awaken all sleeping individuals, and that it is the responsibility of individuals in the household that are capable of assisting others to provide assistance to those who may not be awakened by the alarm sound, or to those who may be incapable of safely evacuating the area unassisted.

### 14. WHAT TO DO WHEN THE ALARM SOUNDS

- 14.1 Alert small children in the home.
- 14.2 Leave immediately by your plan of escape. Every second counts, so don't waste time getting dressed or picking up valuables.
- 14.3 In leaving, don't open any inside door without first feeling its surface. If hot, or if you see smoke seeping through cracks, don't open that door! Instead, use your alternate exit. If inside door is cool, place your shoulder against it, open it slightly and be ready to slam it shut if heat and smoke rush in.
- 14.4 Stay close to the floor if air is smoky. Breathe shallowly through a wet cloth if possible.
- 14.5 Once outside, go to your selected meeting place and make sure everyone is there.
- 14.6 Call the Fire Brigade from your neighbour's home - not from yours!
- 14.7 Don't return to your home until officials say that it is safe to do so.

**For further information on fire safety contact your local Fire Brigade.**

### **15. INSTALLER PLEASE NOTE**

- 15.1 Before you connect the mains power, check wiring polarity.
- 15.2 please check battery is correctly connected and fully charge over 8.0 Volts.
- 15.3 If the alarm 'chirps' again, press the Test button to check the battery condition.
- 15.4 If 'chirps' persists, replace smoke alarm and return to your supplier for replacement.

### **16. WARNING: INSULATION TEST**

- 16.1 **UNDER NO CIRCUMSTANCES MUST AN INSULATION RESISTANCE TEST BE CARRIED OUT ON A CIRCUIT TO WHICH A SMOKE ALARM IS FITTED.**
- 16.2 **THE TEST COULD CAUSE IRREPAIRABLE DAMAGE TO THE INTERNAL CIRCUITRY OF THE SMOKE ALARM AND MAKE IT INOPERATIVE.**
- 16.3 **THE WARRANTY WOULD BE VOID UNDER SUCH CIRCUMSTANCES.**

**NOTE: WEEKLY TESTING IS RECOMMENDED!**

**17. WARRANTY AND LIABILITY**

- 17.1 PSA Products Pty Ltd (ABN: 99 076 468 703) of 17 Millicent Street, Burwood 3125 Victoria, Australia warrants this product for a period of five years from the date of purchase, as reflected on the Authorised Reseller's or Distributor's invoice / receipt provided to you. PSA Products Pty Ltd will repair or replace the product (at the option of PSA Products) due to any manufacturing defect, at the cost of PSA Products Pty Ltd (excluding any labour costs relating to removal or re-installation of product, and transport costs).
- 17.2 This warranty shall not apply to the product if it has been damaged, modified, abused or altered after the date of purchase, or if it fails to operate due to improper maintenance.
- 17.3 To the extent permitted by law, the liability of PSA Products Pty Ltd arising from the sale or under the terms of this limited warranty shall not in any case exceed the cost of replacement and subject to this clause. In no case shall PSA Products Pty Ltd be liable for consequential loss or damages resulting from the failure of the product or breach of this, or: Any other warranty, express or implied, loss or damage caused by failure to abide by the instructions supplied in the leaflets.
- 17.4 To the extent permitted by law, PSA Products Pty Ltd., makes no warranty, expressed or implied, written or oral, including that of merchantability or fitness for any particular purpose, with respect to the consumer replaceable battery if any. A product with non-serviceable built-in battery is covered under warranty of the product as per point 17.1.
- 17.5 This warranty is provided in addition to other rights and remedies you have under law: Our goods come with guarantees that cannot be excluded under the Australian Consumer Law. You are entitled to a replacement or refund for a major failure and compensation for any other reasonably foreseeable loss or damage. You are also entitled to have the goods repaired or replaced if the goods fail to be of acceptable quality and the failure does not amount to a major failure. What constitutes a major failure is set out in the Australian Consumer Law.
- 17.6 To make a claim under warranty, take the product (with a proof of purchase) to the store where you purchased the product or contact PSA Products Pty Ltd. Phone (03) 9888 9889. or Email: [enquiry@psaproducts.com.au](mailto:enquiry@psaproducts.com.au) with details, proof of purchase or expense claim in writing.

**Warranty Form**

Register this product for warranty to ensure fast and effective service. Please visit our website **[www.psaproducts.com.au/registration](http://www.psaproducts.com.au/registration)** to register.

Please retain this warranty section and complete the details below. When you claim Warranty for the product. Please present this section together with the faulty product.

Model: \_\_\_\_\_ Serial Number: \_\_\_\_\_

Date Of Purchase/ Installation: \_\_\_\_\_ Invoice No: \_\_\_\_\_.

Installed By: \_\_\_\_\_  
\_\_\_\_\_  
\_\_\_\_\_  
\_\_\_\_\_  
\_\_\_\_\_

Owner's Details: \_\_\_\_\_

**This smoke alarm has an expected service life of 10 years under normal conditions. We recommend that you should replace the smoke alarm after 10 years from installation date to ensure normal operation. Please use a date label as a reminder.**



**THIS SMOKE ALARM HAS BEEN TESTED AND COMPLIES TO  
AS3786**

**DEAR ELECTRICIAN:  
PLEASE LEAVE THIS MANUAL FOR THE OWNER.  
THANK YOU FOR CHOOSING THIS SMOKE ALARM.**



Tested and Complies to AS3786



N10116

AUSTRALIA PATENT S/N 2008200075  
AUSTRALIAN ELECTRICAL AUTHORITY - CS8736

*Another Quality Product By:*

**PSA Products Pty Ltd**

17 Millicent Street, Burwood, Victoria 3125

Ph: 1300 PSA PRODUCTS(1300 772 776)

Fax: (03) 9888 9993

Email: [enquiry@psaproducts.com.au](mailto:enquiry@psaproducts.com.au)

Website: [www.psaproducts.com.au](http://www.psaproducts.com.au)

1299-7201-01