

7.INSTALLATION NOTE



NOTES:

Keep intercom wires more than 30cm away from ac power to avoid interference
The electric lock is not included in the package, Use 12VDC electric strike only.
Should not exceed 500mA.

Cable Requirements

1. CAT5e or CAT6 network cable connection mode:

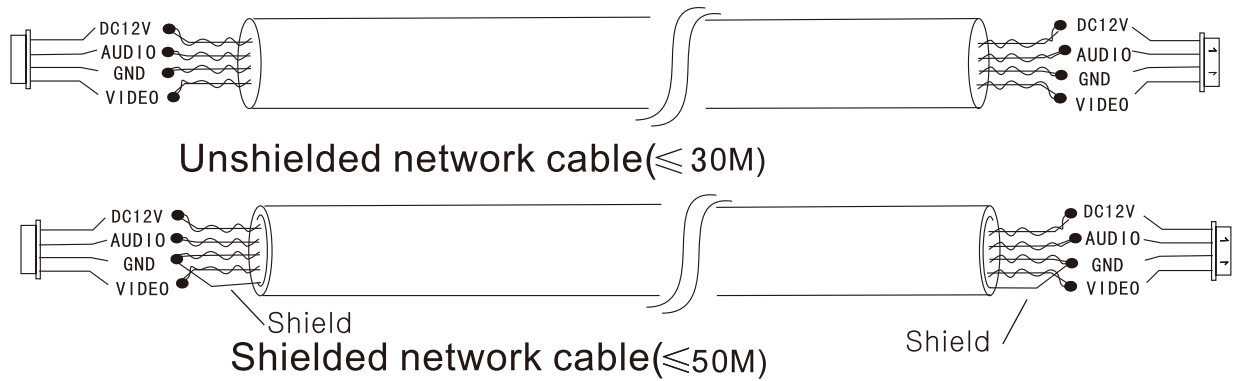

2. 4C ordinary unshielded and shielded wire connection mode:

Distance $\leq 50m$ ($4 \times 0.5mm^2$)

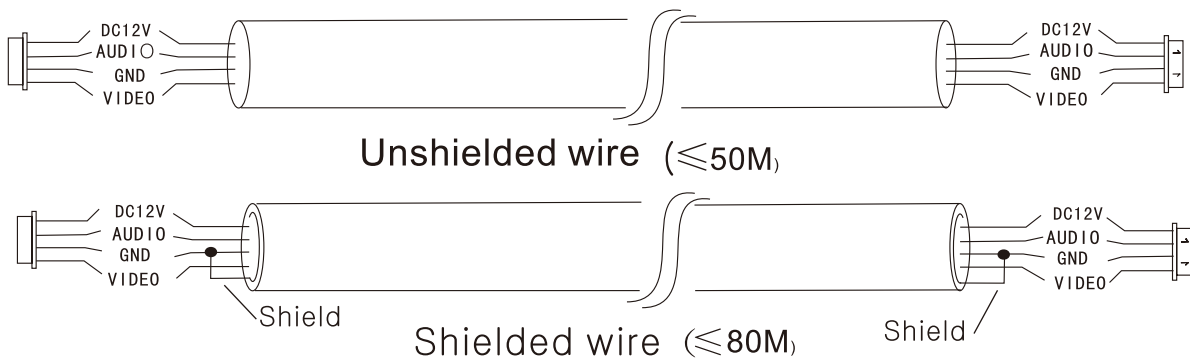

3.3C ordinary unshielded +75 ohm coax video wire connection mode:

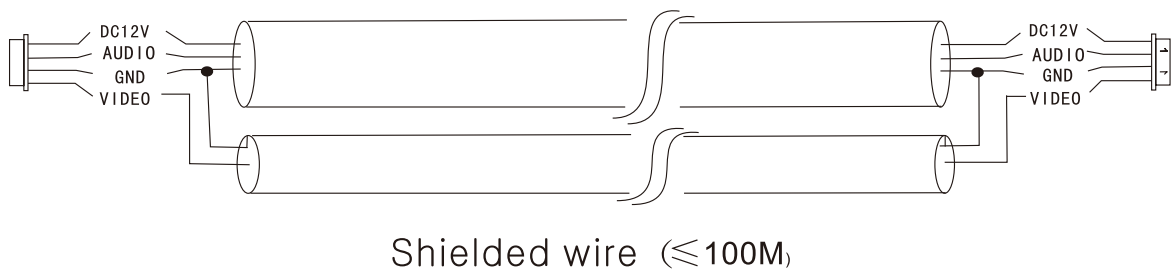

8. WIRING DIAGRAM



First monitor must be set as **MASTER**. All other monitors must be set as **SLAVE**. This can be done in the **SETTINGS** menu.
MONITOR ID SETTING
 Master=01, Slave=02 to 06

Note:

HD Monitor can accept **AHD** or **CVBS** analog signals. If using HD monitor with **CVBS** analog door station, you must reboot the monitor from the menu system after connecting the camera.

