

HiLook



Network Bullet Camera

Quick Start Guide

Quick Start Guide

COPYRIGHT ©2018 Hangzhou Hikvision Digital Technology Co., Ltd.

ALL RIGHTS RESERVED.

Any and all information, including, among others, wordings, pictures, graphs are the properties of Hangzhou Hikvision Digital Technology Co., Ltd. or its subsidiaries (hereinafter referred to be “Hikvision”). This user manual (hereinafter referred to be “the Manual”) cannot be reproduced, changed, translated, or distributed, partially or wholly, by any means, without the prior written permission of Hikvision. Unless otherwise stipulated, Hikvision does not make any warranties, guarantees or representations, express or implied, regarding to the Manual.

About this Manual

This Manual is applicable to Network Bullet Camera.

The Manual includes instructions for using and managing the product. Pictures, charts, images and all other information hereinafter are for description and explanation only. The information contained in the Manual is subject to change, without notice, due to firmware updates or other reasons. Please find the latest version in the company website (<http://overseas.hikvision.com/en/>).

Please use this user manual under the guidance of professionals.

Trademarks Acknowledgement

HiLook and other Hikvision’s trademarks and logos are the properties of Hikvision in various jurisdictions. Other trademarks and logos mentioned below are the properties of their respective owners.

Legal Disclaimer

TO THE MAXIMUM EXTENT PERMITTED BY APPLICABLE LAW, THE PRODUCT DESCRIBED, WITH ITS HARDWARE, SOFTWARE AND FIRMWARE, IS PROVIDED "AS IS", WITH ALL FAULTS AND ERRORS, AND HIKVISION MAKES NO WARRANTIES, EXPRESS OR IMPLIED, INCLUDING WITHOUT LIMITATION, MERCHANTABILITY, SATISFACTORY QUALITY, FITNESS FOR A PARTICULAR PURPOSE, AND NON-INFRINGEMENT OF THIRD PARTY. IN NO EVENT WILL HIKVISION, ITS DIRECTORS, OFFICERS, EMPLOYEES, OR AGENTS BE LIABLE TO YOU FOR ANY SPECIAL, CONSEQUENTIAL, INCIDENTAL, OR INDIRECT DAMAGES, INCLUDING, AMONG OTHERS, DAMAGES FOR LOSS OF BUSINESS PROFITS, BUSINESS INTERRUPTION, OR LOSS OF DATA OR DOCUMENTATION, IN CONNECTION WITH THE USE OF THIS PRODUCT, EVEN IF HIKVISION HAS BEEN ADVISED OF THE POSSIBILITY OF SUCH DAMAGES.

REGARDING TO THE PRODUCT WITH INTERNET ACCESS, THE USE OF PRODUCT SHALL BE WHOLLY AT YOUR OWN RISKS. HIKVISION SHALL NOT TAKE ANY RESPONSIBILITIES FOR ABNORMAL OPERATION, PRIVACY LEAKAGE OR OTHER DAMAGES RESULTING FROM CYBER ATTACK, HACKER ATTACK, VIRUS INSPECTION, OR OTHER INTERNET SECURITY RISKS; HOWEVER, HIKVISION WILL PROVIDE TIMELY TECHNICAL SUPPORT IF REQUIRED.

SURVEILLANCE LAWS VARY BY JURISDICTION. PLEASE CHECK ALL RELEVANT LAWS IN YOUR JURISDICTION BEFORE USING THIS PRODUCT IN ORDER TO ENSURE THAT YOUR USE CONFORMS THE APPLICABLE LAW. HIKVISION SHALL NOT BE LIABLE IN THE EVENT THAT THIS PRODUCT IS USED WITH ILLEGITIMATE PURPOSES.

IN THE EVENT OF ANY CONFLICTS BETWEEN THIS MANUAL AND THE APPLICABLE LAW, THE LATER PREVAILS.

Regulatory Information

FCC Information

FCC compliance: This equipment has been tested and found to comply with the limits for a digital device, pursuant to part 15 of the FCC Rules. These limits are designed to provide reasonable protection against harmful interference when the equipment is operated in a commercial environment. This equipment generates, uses, and can radiate radio frequency energy and, if not installed and used in accordance with the instruction manual, may cause harmful interference to radio communications. Operation of this equipment in a residential area is likely to cause harmful interference in which case the user will be required to correct the interference at his own expense.

FCC Conditions

This device complies with part 15 of the FCC Rules. Operation is subject to the following two conditions:

1. This device may not cause harmful interference.
2. This device must accept any interference received, including interference that may cause undesired operation.

EU Conformity Statement



This product and - if applicable - the supplied accessories too are marked with "CE" and comply therefore with the applicable harmonized European standards listed under the EMC Directive 2014/30/EU, the RoHS Directive 2011/65/EU.



2012/19/EU (WEEE directive): Products marked with this symbol cannot be disposed of as unsorted municipal waste in the European Union. For proper recycling, return this product to your local supplier upon the purchase of equivalent new equipment, or dispose of it at designated collection points. For more information see: www.recyclethis.info



2006/66/EC (battery directive): This product contains a battery that cannot be disposed of as unsorted municipal waste in the European Union. See the product documentation for specific battery information. The battery is marked with this symbol, which may include lettering to indicate cadmium (Cd), lead (Pb), or mercury (Hg). For proper recycling, return the battery to your supplier or to a designated collection point. For more information see: www.recyclethis.info

Industry Canada ICES-003 Compliance

This device meets the CAN ICES-3 (A)/NMB-3(A) standards requirements.



Safety Instruction

These instructions are intended to ensure that user can use the product correctly to avoid danger or property loss.

The precaution measure is divided into “Warnings” and “Cautions”

Warnings: Serious injury or death may occur if any of the warnings are neglected.

Cautions: Injury or equipment damage may occur if any of the cautions are neglected.

	
Warnings Follow these safeguards to prevent serious injury or death.	Cautions Follow these precautions to prevent potential injury or material damage.



Warnings

For Network Camera:

- Proper configuration of all passwords and other security settings is the responsibility of the installer and/or end-user.
- In the use of the product, you must be in strict compliance with the electrical safety regulations of the nation and region. Please refer to technical specifications for detailed information.
- Input voltage should meet both the SELV (Safety Extra Low Voltage) and the Limited Power Source with 12 VDC according to the IEC60950-1 standard. Please refer to technical specifications for detailed information.
- Do not connect several devices to one power adapter as adapter overload may cause over-heating or a fire hazard.
- Please make sure that the plug is firmly connected to the power socket. When the product is mounted on wall or ceiling, the device shall be firmly fixed.

- If smoke, odor or noise rise from the device, turn off the power at once and unplug the power cable, and then please contact the service center.

For NVR Device:

- Proper configuration of all passwords and other security settings is the responsibility of the installer and/or end-user.
- In the use of the product, you must be in strict compliance with the electrical safety regulations of the nation and region. Please refer to technical specifications for detailed information.
- Input voltage should meet both the SELV (Safety Extra Low Voltage) and the Limited Power Source with 100~240 VAC, 48 VDC or 12 VDC according to the IEC60950-1 standard. Please refer to technical specifications for detailed information.
- Do not connect several devices to one power adapter as adapter overload may cause over-heating or a fire hazard.
- Please make sure that the plug is firmly connected to the power socket.
- If smoke, odor or noise rise from the device, turn off the power at once and unplug the power cable, and then please contact the service center.
- If the POE ports of device do not comply with Limited Power Source, the additional equipment connected to POE ports shall have fire enclosure.
- The USB interface of the /P devices can be connected with the mouse and U-flash disk storage device only.



Cautions

For Network Camera:

- Make sure the power supply voltage is correct before using the camera.
- Do not drop the camera or subject it to physical shock.
- Do not touch sensor modules with fingers. If cleaning is necessary, use clean cloth with a bit of ethanol and wipe it gently. If the camera will not be used for an extended period, please replace the lens cap to protect the sensor from dirt.
- Do not aim the camera at the sun or extra bright places. Blooming or smearing may occur otherwise (which is not a malfunction), and affect the endurance of sensor at the same time.
- The sensor may be burned out by a laser beam, so when any laser equipment is in using, make sure that the surface of sensor will not be exposed to the laser beam.
- The operating temperature shall be -30°C to $+60^{\circ}\text{C}$ (-22°F to $+140^{\circ}\text{F}$). Do not place the camera in extremely hot, cold, dusty or damp locations, and do not expose it to high electromagnetic radiation.
- To avoid heat accumulation, good ventilation is required for operating environment.
- Keep the camera away from liquid while in use.

- While in delivery, the camera shall be packed in its original packing, or packing of the same texture.
- Regular part replacement: a few parts (e.g. electrolytic capacitor) of the equipment shall be replaced regularly according to their average enduring time. The average time varies because of differences between operating environment and using history, so regular checking is recommended for all the users. Please contact with your dealer for more details.
- Improper use or replacement of the battery may result in hazard of explosion. Replace with the same or equivalent type only. Dispose of used batteries according to the instructions provided by the battery manufacturer.
- If the product does not work properly, please contact your dealer or the nearest service center. Never attempt to disassemble the camera yourself. (We shall not assume any responsibility for problems caused by unauthorized repair or maintenance.)

For NVR Device:

Before connecting and operating your device, please be advised of the following tips:

- Ensure unit is installed in a well-ventilated, dust-free environment.
- Unit is designed for indoor use only.
- Keep all liquids away from the device.
- Ensure environmental conditions meet factory specifications.

Network Bullet Camera • Quick Start Guide

- Ensure unit is properly secured to a rack or shelf. Major shocks or jolts to the unit as a result of dropping it may cause damage to the sensitive electronics within the unit.
- Use the device in conjunction with an UPS if possible.
- Power down the unit before connecting and disconnecting accessories and peripherals.
- A factory recommended HDD should be used for this device.
- Improper use or replacement of the battery may result in hazard of explosion. Replace with the same or equivalent type only. Dispose of used batteries according to the instructions provided by the battery manufacturer.

Power Supply Instructions for NVR Device:

Use only power supplies listed in the user instructions.

Standard	Power Supply Models	Manufacturer
European	MSA-C2000IC 12.0-24P-DE	MOSO POWER SUPPLY TECHNOLOGY CO.,LTD
	ADS-26FSG-1 2 12024EPG	SHENZHEN HONOR ELECTRONIC CO.,LTD
British	MSA-C2000IC 12.0-24P-GB	MOSO POWER SUPPLY TECHNOLOGY CO.,LTD
	ADS-26FSG-1 2 12024EPB	SHENZHEN HONOR ELECTRONIC CO.,LTD

Table of Contents

1 Introduction	11
1.1 Application	11
1.2 NVR Appearance	12
1.2.1 Front Panel.....	12
1.2.2 Rear Panel	13
1.3 Camera Appearance	14
2 NVR Installation.....	16
2.1 Precautions	16
2.2 Hard Disk Installation	16
3 Camera Installation.....	19
3.1 Antenna Installation	19
3.2 Wall/Ceiling Mounting	20
3.3 Waterproof Measures	23
3.3.1 Waterproof Network Cable	23
3.3.2 Waterproof Other Cables	25
4 Menu Operation	27
4.1 Startup and Shutdown	27
4.2 Activate Your NVR.....	27
4.3 Use the Setup Wizard	28
4.4 Add IP Cameras.....	29
4.4.1 Wi-Fi Kit Cameras	29
4.4.2 Other Cameras	29
4.5 Hik-Connect Setup.....	29

1 Introduction

1.1 Application

The Wi-Fi kit includes four network cameras and a NVR device. The NVR works as a wireless network router, and the camera connects to the NVR's Wi-Fi automatically after the camera is powered on.

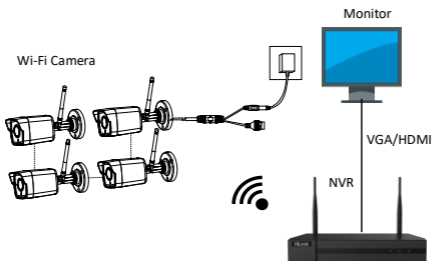

Note:

If you want to access the NVR via Internet, connect your NVR with the router.

1.2 NVR Appearance

1.2.1 Front Panel

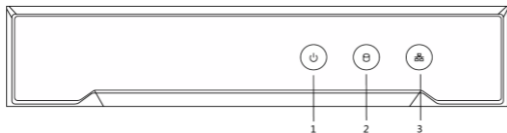





Figure 1-1 Front Panel

Table 1-1 Description

No.	Icon	Description
1		Indicator turns red when NVR is powered up.
2		Indicator lights in red when there is data transmission.
3		Indicator blinks blue when network connection is functioning properly.

1.2.2 Rear Panel

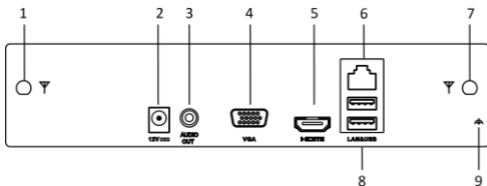

Figure 1-2 Rear Panel

Table 1-2 Description

No.	Icon	Description
1	Wi-Fi Antenna	Wi-Fi antenna interface.
2	Power supply	12 VDC power supply.
3	Audio out	One audio output.
4	VGA	VGA interface
5	HDMI	HDMI video output connector.
6	LAN	One RJ-45 10M/100M self-adaptive Ethernet interface
7	Wi-Fi Antenna	Wi-Fi antenna interface.

No.	Icon	Description
8	USB	Two USB 2.0 interface.
9	Ground	Ground (needs to be connected when device starts up).

1.3 Camera Appearance

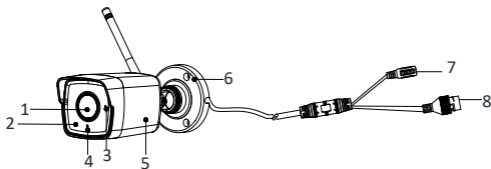

Figure 1-3 Overview

Table 1-3 Description

No.	Description
1	Lens
2	IR LED Cover
3	Mic

No.	Description
4	<p>Status Indicator</p> <ul style="list-style-type: none"> ● Flashing Blue: Normal Wi-Fi connection. ● Solid Red: The camera is during startup. ● Flashing red and blue: The camera has started and starts Wi-Fi configuration. ● Flashing Red: <ul style="list-style-type: none"> Fast Flashing: The network connection failed. Slow Flashing: Memory card error or other problems.
5	Camera Body
6	Bracket
7	Power Interface
8	Network Interface

2 NVR Installation

2.1 Precautions

During installation of the NVR:

- Use brackets for rack mounting.
- Ensure ample room for audio and video cables.
- When routing cables, ensure that the bend radius of the cables is no less than five times than its diameter.
- Connect the alarm cable.
- Allow at least 2cm (≈0.75-inch) of space between racks mounted devices.
- Ensure the NVR is grounded.
- Environmental temperature should be within the range of -10 to +55 °C, +14 to +131 °F.
- Environmental humidity should be within the range of 10% to 90%.

2.2 Hard Disk Installation

Before you start:

- If the NVR has been installed with hard disks, skip this section.
- Disconnect the power from the NVR before installing a hard disk drive (HDD). A factory recommended HDD should be used for this installation.

Tools Required: Screwdriver.

Steps:

1. Remove the cover from device by unfastening the screws on panels.

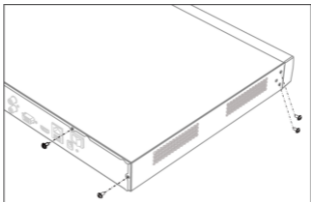

Figure 2-1 Remove Cover

2. Connect the data cable and power cable.
 - a) Connect one end of data cable to the device motherboard.
 - b) Connect the other end of data cable to HDD.
 - c) Connect one end of power cable to HDD.
 - d) Connect the other end of power cable to the device motherboard.

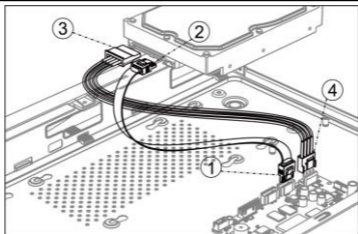

Figure 2-2 Connect Cables

3. Set the device up, match HDD screw threads with the reserved holes on the device bottom, and fix HDD with screws.

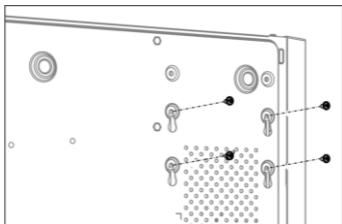

Figure 2-3 Fix HDD to Device Bottom

4. (Optional) Repeat the steps above to install other HDDs.
5. Reinstall the device cover and fasten screws.

3 Camera Installation

Before you start:

- Make sure the device in the package is in good condition and all the assembly parts are included.
- The standard power supply is 12 VDC. Make sure your power supply matches with your camera.
- Make sure all the related equipment is power-off during the installation.
- Check the specification of the products for the installation environment.
- Make sure that the wall is strong enough to withstand four times the weight of the camera and the bracket.

For the camera that supports IR, you are required to pay attention to the following precaution to prevent IR reflection:

Make sure that there is no reflective surface too close to the camera lens. The IR light from the camera may reflect back into the lens causing reflection.

3.1 Antenna Installation

Steps:

Align the antenna to the interface and rotate it clockwise to install it to the camera.

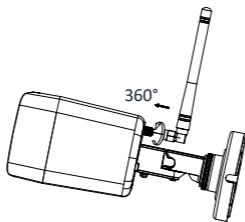

Figure 3-1 Install the Antenna

3.2 Wall/Ceiling Mounting

Steps:

1. Paste the drill template on the wall or ceiling and drill holes according to the marked holes on the drill template.

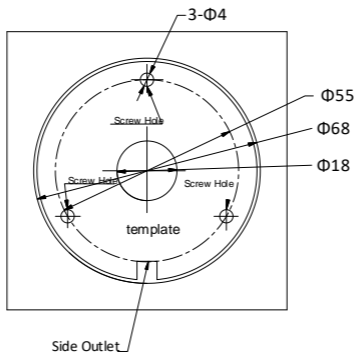

Figure 3-2 Drill the Holes

2. If you need to route cables through the wall or ceiling, cut a cable hole according to the drill template. Skip this step if you want to route the cables on the surface of the wall or ceiling.
3. Route the cables of the camera.
4. Install the camera to the wall or ceiling with screws.

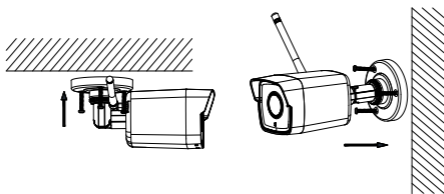

Figure 3-3 Install the Camera

5. Adjust the view angle of the camera.

- 1). Loosen the fixing ring to adjust the pan angle.
- 2). Loosen the adjusting screw 1 ring to adjust the tilt angle.
- 3). Loosen the adjusting screw 2 to adjust the rotation angle.
- 4). Tighten the fixing ring and the adjusting screws.

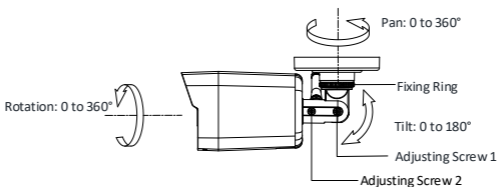

Figure 3-4 View Angle Adjustment

3.3 Waterproof Measures

If the camera is installed outdoor, you should use the waterproof accessory or tapes to waterproof the cables. Otherwise the cables might get wet or a short circuit occurs.

3.3.1 Waterproof Network Cable

Use the waterproof accessory to waterproof the network cable after the camera is secured on the installation surface.

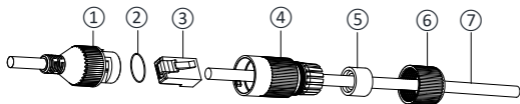

Figure 3-5 Waterproof Accessory Components

Table 3-1 Components

No.	Components
1	Camera's Network Interface Socket
2	O-Type Gasket
3	Network Plug
4	Waterproof Endcap
5	Waterproof Rubber Gasket
6	Lock Nut

No.	Components
7	Network Cable from Router/Switch

Steps:

1. Feed the plugless network cable (7) through the lock nut (6), waterproof the rubber gasket (5) (rubber gasket inset ridge must face waterproof endcap), and the waterproof endcap (4) in order.
2. Crimp an RJ-45 network plug (3) onto the end of the cable, taking care to insert the twisted pairs of wires in correct order.
3. Place the O-type gasket (2) onto the end of the camera's network interface socket (1).
4. Insert the network plug (3) into the camera's network interface socket (1).
5. Insert the waterproof rubber gasket (5) into the waterproof endcap (4), and secure lock nut (6) with the waterproof endcap (4).
6. Align the snap on the waterproof endcap (4) with the notch on the camera's network interface socket (1), and then secure the waterproof endcap (4) to the camera's network interface socket (1) to finish installation.

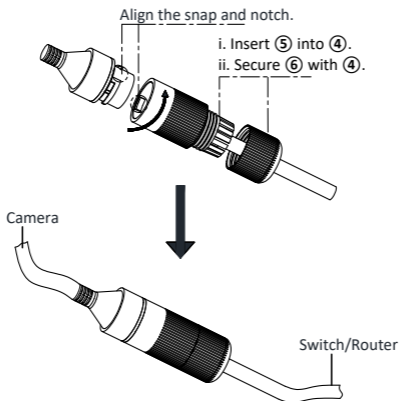

Figure 3-6 Waterproof Accessory Installation

3.3.2 Waterproof Other Cables

After routing and connecting the cables, use the waterproof tapes to wrap up the cables. Connected cables and spare cables both should be wrapped up as the figures below.

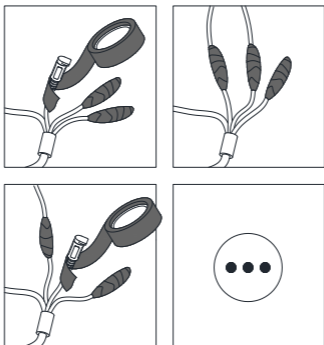

Figure 3-7 Waterproof Cables

4 Menu Operation

4.1 Startup and Shutdown

To start your NVR:

Steps:

1. Check the power supply is plugged into an electrical outlet. It is HIGHLY recommended that an Uninterruptible Power Supply (UPS) be used in conjunction with the device. The Power button on the front panel should be red, indicating the device is receiving the power.
2. Press the power switch on the panel. The Power LED should turn blue. The unit will begin to start.

After the device starts up, the wizard will guide you through the initial settings, including modifying password, date and time settings, network settings, HDD initializing, and recording.

To shut down the NVR:

Steps:

1. Enter the Shutdown menu. Go to **Menu > Shutdown**.
2. Select **Shutdown**.
3. Click **Yes**.

4.2 Activate Your NVR

Purpose:

For the first-time access, you need to activate the NVR by setting an admin password. No operation is allowed before activation. You can also activate the NVR via Web Browser, SADP or client software.

1. Input the same password in the text field of Create New Password and Confirm New Password.



STRONG PASSWORD RECOMMENDED– *We highly recommend you create a strong password of your own choosing (using a minimum of 8 characters, including upper case letters, lower case letters, numbers, and special characters) in order to increase the security of your product. And we recommend you reset your password regularly, especially in the high security system, resetting the password monthly or weekly can better protect your product.*

2. Enter IP Camera Activation Password to set the IP camera activation password.
3. Select **Area/Country**.
4. Click **OK**.

4.3 Use the Setup Wizard

The Setup Wizard can guide you to configure the system resolution, system date/time, HDD initialization, IP camera management, etc.

4.4 Add IP Cameras

4.4.1 Wi-Fi Kit Cameras

The supplied Wi-Fi kit cameras can connect to the NVR automatically after it is powered on.

4.4.2 Other Cameras

For the other cameras, follow the steps below to configure the Wi-Fi parameters and add the cameras.

1. Go to Menu > Configuration > WiFi.
2. Configure wireless network parameters, including Network Bridging, SSID, Security Mode, and Key.
3. Access the Web of the camera.
4. Go to Configuration > Network > Advanced Settings > Wi-Fi to set the Wi-Fi parameters.

Note:

For the detailed information, see the User Manual of the Network Camera.

5. Click to select an idle window in the live view mode of the NVR.
6. Click  in the center of the window.
7. Select the detected IP camera and click Add to add it directly.

4.5 Hik-Connect Setup

The Hik-Connect mobile client can generally manage various kinds of devices. With the client, you can remotely control NVRs, DVRs, and network cameras, etc.

Steps:

1. Download and install the Hik-Connect app by searching "Hik-Connect" in App Store or Google Play™.



2. Launch the app and register for a Hik-Connect user account.
3. Log in Hik-Connect app after registration.
4. Use a network cable to connect the NVR with a router.
5. In the Hik-Connect app, tap "+" on the upper-right corner and then scan the QR code of the NVR to add the NVR.
6. After the adding, you can get the live view, play back the videos in the app.

Note:

For detailed information, refer to the user manual of the Hik-Connect app.



First Choice for Security Professionals

UD12188B

www.hikvision.com